

# LED Exterior Recessed

**ER30203**  
INSTALLATION SHEET

## START FROM HERE

- Make sure **POWER** is **COMPLETELY OFF** at the fuse box
- Have your fixture installed by a qualified licensed electrician
- Prepare everything in a clear area
- Wear gloves at all times during this installation
- Read instructions carefully before you start assembly
- Keep this installation sheet for future reference

## Please Note:

- This Kuzco fixture comes with pre-wired LED module(s)
- Unless instructed, Do Not touch any part of the LED module(s) as any unnecessary contact with the module could cause permanent damage
- Use ELV (Electronic Low Voltage) type of dimmer for dimming application
- 120V input voltage

**Technical Support:** 1-855-855-8926

- 1.** Remove fixture from its original packaging
- 2.** Separate the backplate (**1c**) from the fixture (**3a**) by removing the fixture screws (**2b**)
- 3.** Make proper electrical connections (**black to hot "L", white to neutral "N", ground to "GND"**) with wire nuts (**1b**) provided in hardware package
- 4.** Attach backplate (**1c**) to electrical junction box (**1a**) using junction box screws provided (**1e**) in hardware package
- 5.** Secure fixture (**3a**) to backplate (**1c**) with screws (**2b**)
- 6.** To prevent moisture from entering the electrical junction box (**1a**) and causing a short, seal around the top and side perimeter between the fixture and the wall surface with weather resistant caulking (**Illustration 1**). The space at the bottom should be left un-caulked to prevent moisture build up

**Illustration 1**

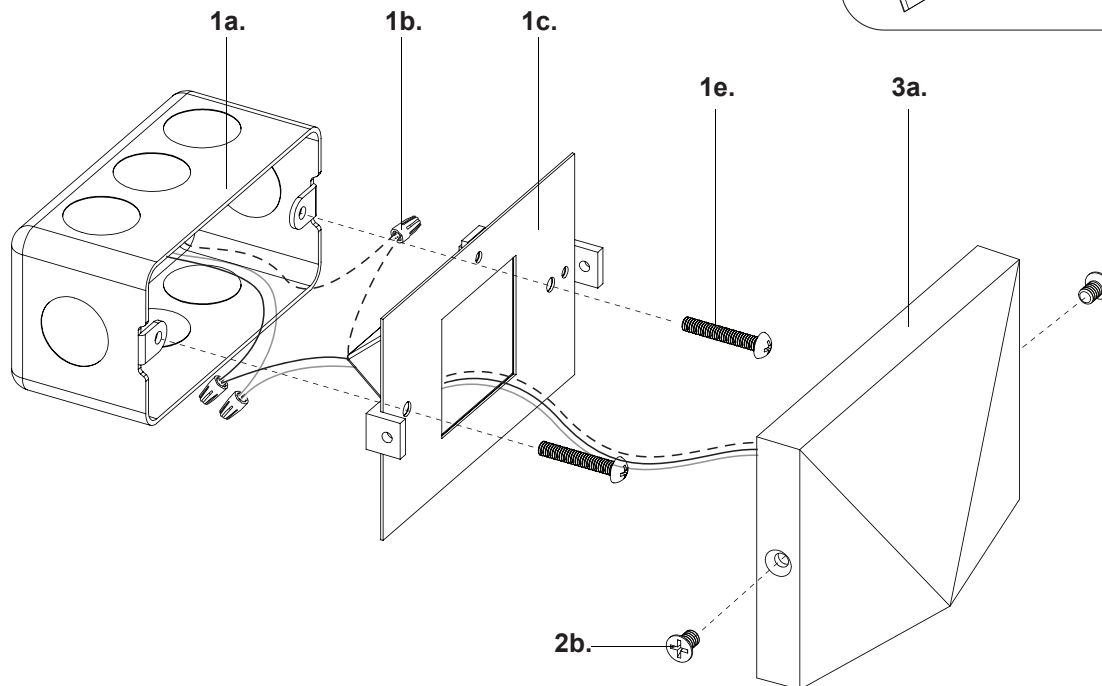
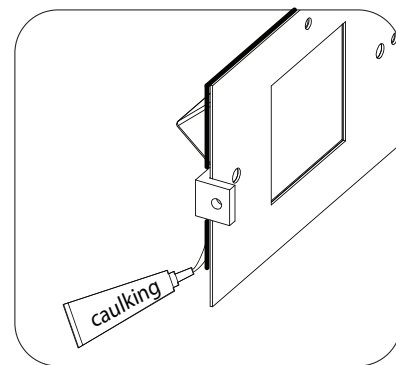

**KUZCO**

19054 28th Avenue Surrey, BC Canada V3Z 6M3  
T: 604 538 7162 TF: 1-855 85 KUZCO F: 604 538 7196  
W: kuzcolighting.com  
20210309